

INDIVIDUAL SPECIFICATION SHEET

Product Name: 片式 NTC 热敏电阻

Part Number: TNA Series

Revision: A



Dongguan TLC Electronic Technology Co., LTD

No.18,5th GaoLi Road,TangXia Town,DongGuan,GuangDong,P.R China 523710

TEL: 86-0769-3892 0511

FAX: 86-0769-8793 2077

Http: www.tlcet.com.cn

Rev.	Effective Date	Changed Contents
A	2021-7-15	New release

The individual specification sheet are the property of Dongguan TLC electronic technology Co.,Ltd and shall not be copied or used as commercial purposes without permission.

PREPEARED BY



APPROVED BY



1 外形尺寸 Shape and Dimensions

- 尺寸：见图 1 和表 1
- PCB 焊盘：见图 2 和表 1

- Dimensions: See Fig.1 and Table 1.
- Recommended PCB pattern for reflow soldering: See Fig.2 and Table 1



图 1 Fig.1



图 2 Fig.2

表 1 (Table 1)

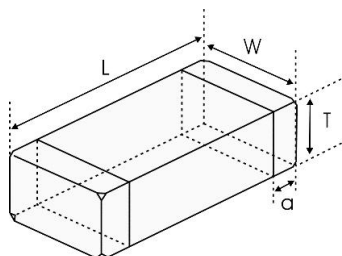
单位 unit: inch[mm]

类别 Type	L	W	T	a	A	B	C
A [0402]	0.039±0.006 [1.0±0.15]	0.020±0.006 [0.5±0.15]	0.020±0.006 [0.5±0.15]	0.010±0.004 [0.25±0.1]	[0.45-0.55]	[0.4-0.5]	[0.45-0.55]

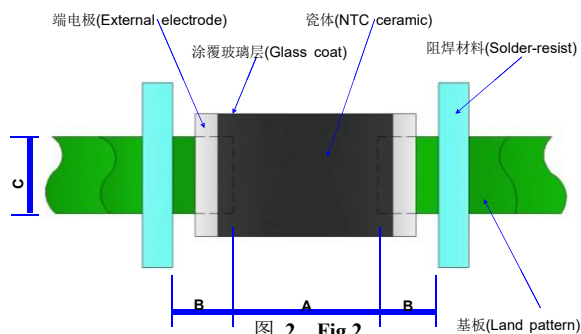
2 产品标识 (料号) Product Identification(Part Number)

TN A 103 F 3435 F A T
 ① ② ③ ④ ⑤ ⑥ ⑦ ⑧

① 类别 Type	
TN	片式 NTC 热敏电阻器 Chip NTC Thermistor

② 外形尺寸 (mm) External Dimensions (L×W×T)	
Z[0201]	0.60×0.30×0.30
A[0402]	1.00×0.50×0.50
F[0603]	1.60×0.80×0.80
P[0805]	2.00×1.25×0.85
N[1206]	3.20×1.60×0.85

⑧ 包装方式 Package	
T: 编带包装	B: 散包装

③ 25°C 的零功率电阻 Nominal Zero-Power Resistance at 25°C	
222	2.2kΩ
103	10kΩ
474	470kΩ

④ 电阻值公差 Tolerance of Resistance	
F	±1%
G	±2%
H	±3%
J	±5%

⑤ B 值常数 B Constant	
3435	3435K
3950	3950K
4250	4250K

⑥ B 值公差 Tolerance of B Constant	
F	±1%
H	±3%

⑦ B 值计算方式 B constant calculation method	
A	25°C&85°C
B	25°C&50°C

3 电气特性 Electrical Characteristics

1) F 档 F Series

型号 Part No	电阻值 Resistance (25°C) (kΩ)	B 常数 B Constant (25/50°C) (K)	B 常数 B Constant (25/85°C) (K)	允许工作电流 Permissible Operating Current (25°C) (mA)	耗散系数 Dissipation Factor (mW/°C)	热时间常数 Thermal Time Constant (s)	额定功率 Rated Electric Power(25°C) (mW)	工作温度 Operating ambient temperature (°C)
TNA103F3435FAT	10±1%	3380±1%	3435±1%	0.31	1.0	<3	100	-40~+125
TNA103F3450FBT	10±1%	3450±1%	3500	0.31				
TNA103F3950FBT	10±1%	3950±1%	3987	0.31				
TNA223F3950FBT	22±1%	3950±1%	3987	0.21				
TNA333F4050FBT	33±1%	4050±1%	4100	0.17				
TNA473F4050FBT	47±1%	4050±1%	4100	0.14				
TNA683F4150FBT	68±1%	4150±1%	4210	0.12				
TNA104F3950FBT	100±1%	3950±1%	3987	0.10				
TNA104F4250FBT	100±1%	4250±1%	4310	0.10				
TNA474F4050FAT	470±1%	4000±1%	4050±1%	0.04				

2) H 档 H Series

型号 Part No	电阻值 Resistance (25°C) (kΩ)	B 常数 B Constant (25/50°C) (K)	B 常数 B Constant (25/85°C) (K)	允许工作电流 Permissible Operating Current (25°C) (mA)	耗散系数 Dissipation Factor (mW/°C)	热时间常数 Thermal Time Constant (s)	额定功率 Rated Electric Power(25°C) (mW)	工作温度 Operating ambient temperature (°C)
TNA103H3435FAT	10±3%	3380±1%	3435±1%	0.31	1.0	<3	100	-40~+125
TNA103H3450FBT	10±3%	3450±1%	3500	0.31				
TNA103H3950FBT	10±3%	3950±1%	3987	0.31				
TNA223H3950FBT	22±3%	3950±1%	3987	0.21				
TNA333H4050FBT	33±3%	4050±1%	4100	0.17				
TNA473H4050FBT	47±3%	4050±1%	4100	0.14				
TNA683H4150FBT	68±3%	4150±1%	4210	0.12				
TNA104H3950FBT	100±3%	3950±1%	3987	0.10				
TNA104H4250FBT	100±3%	4250±1%	4310	0.10				

3) J 档 J Series

型号 Part No	电阻值 Resistance (25°C) (kΩ)	B 常数 B Constant (25/50°C) (K)	B 常数 B Constant (25/85°C) (K)	允许工作电流 Permissible Operating Current (25°C) (mA)	耗散系数 Dissipation Factor (mW/°C)	热时间常数 Thermal Time Constant (s)	额定功率 Rated Electric Power(25°C) (mW)	工作温度 Operating ambient temperature (°C)
TNA103J3435FAT	10±5%	3380±1%	3435±1%	0.31	1.0	<3	100	-40~+125
TNA103J3450FBT	10±5%	3450±1%	3500	0.31				
TNA103J3950FBT	10±5%	3950±1%	3987	0.31				
TNA223J3950FBT	22±5%	3950±1%	3987	0.21				
TNA333J4050FBT	33±5%	4050±1%	4100	0.17				
TNA473J4050FBT	47±5%	4050±1%	4100	0.14				
TNA683J4150FBT	68±5%	4150±1%	4210	0.12				
TNA104J3950FBT	100±5%	3950±1%	3987	0.10				
TNA104J4250FBT	100±5%	4250±1%	4310	0.10				
TNA474J4050FAT	470±5%	4000±1%	4050±1%	0.04				

4 检验和测试程序

■ 测试条件

如无特别规定，检验和测试的标准大气环境条件如下：

- 环境温度：20±15°C；
- 相对湿度：65±20%；
- 气压：86 kPa~106 kPa

如果对测试结果有异议，则在下述条件下测试：

- 环境温度：25±2°C；
- 相对湿度：65±5%
- 气压：86kPa ~ 106kPa

检查设备

外观检查：20 倍放大镜；
阻值检查：热敏电阻测试仪

4 Test and Measurement Procedures

■ Test Conditions

Unless otherwise specified, the standard atmospheric conditions for measurement/test as:

- Ambient Temperature: 20±15°C
- Relative Humidity: 65±20%
- Air Pressure: 86kPa to 106kPa

If any doubt on the results, measurements/tests should be made within the following limits:

- Ambient Temperature: 25±2°C
- Relative Humidity: 65±5%
- Air Pressure: 86kPa to 106kPa

■ Inspection Equipment

Visual Examination: 20× magnifier
Resistance value test: Thermistor resistance tester

5 电性测试 Electrical Test

序号No.	项目Items	测试方法及备注Test Methods and Remarks
1	25°C零功率电阻值 Nominal Zero-Power Resistance at 25°C(R25)	环境温度Ambient temperature: 25±0.05°C 测试功率Measuring electric power: ≤0.1mW
2	B 值常数 Nominal B Constant	<p>分别在环境温度25±0.05°C, 50±0.05°C或85±0.05°C下测量电阻值。 Measure the resistance at the ambient temperature of 25±0.05°C, 50±0.05°C or 85±0.05°C.</p> $B(25-50^{\circ}\text{C}) = \frac{\ln R_{25} - \ln R_{50}}{1/T_{25} - 1/T_{50}} \quad B(25-85^{\circ}\text{C}) = \frac{\ln R_{25} - \ln R_{85}}{1/T_{25} - 1/T_{85}}$ <p>T: 绝对温度 (K) Absolute temperature (K)</p>
3	热时间常数 Thermal Time Constant	<p>在零功率条件下, 当热敏电阻的环境温度发生急剧变化时, 热敏电阻组件产生最初温度T0 与最终温度T1 两者温度差的63.2%的温度变化所需要的时间, 通常以秒(S)表示。 The total time for the temperature of the thermistor to change by 63.2% of the difference from ambient temperature T₀(°C) to T₁(°C) by the drastic change of the power applied to thermistor from Non-zero Power to Zero-Power state, normally expressed in second(S).</p>
4	耗散系数 Dissipation Factor	<p>在一定环境温度下, NTC 热敏电阻通过自身发热使其温度升高 1°C时所需要的功率, 通常以 mW/°C表示。可由下面公式计算: The required power which makes the NTC thermistor body temperature raise 1°C through self-heated, normally expressed in milliwatts per degree Celsius (mW/°C). It can be calculated by the following formula:</p> $\delta = \frac{W}{T - T_0}$
5	额定功率 Rated Power	<p>在环境温度 25°C下因自身发热使表面温度升高 100°C所需要的功率。 The necessary electric power makes thermistor's temperature rise 100°C by self-heating at ambient temperature 25°C.</p>
6	允许工作电流 Permissible operating current	<p>在静止空气中通过自身发热使其升温为 1°C的电流。 The current that keep body temperature of chip NTC on the PC board in still air rising 1°C by self-heating.</p>

6 信赖性试验 Reliability Test

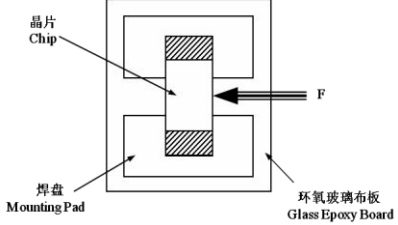
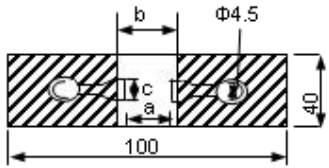
项目 Items	测试标准 Standard	测试方法及备注 Test Methods and Remarks	要求 Requirements																														
端头附着力 Terminal Strength	IEC 60068-2-21	<p>将芯片焊接在测试基板上（如右图所示的环氧玻璃布板），按箭头所示方向施加作用力；</p> <p>Solder the chip to the testing jig (glass epoxy board shown in the right) using eutectic solder. Then apply a force in the direction of the arrow.</p>	<p>端电极无脱落且瓷体无损伤。</p> <p>No removal or split of the termination or other defects shall occur.</p> 																														
抗弯强度 Resistance to Flexure	IEC 60068-2-21	<p>将晶片焊接在测试基板上（如右图所示的环氧玻璃布板），按下图箭头所示方向施加作用力；</p> <p>Solder the chip to the test jig (glass epoxy board shown in the right) using a eutectic solder. Then apply a force in the direction shown as follow;</p> <table border="1" data-bbox="496 1077 1034 1249"> <thead> <tr> <th>尺寸 Size</th> <th>F</th> <th>保持时间 Duration</th> </tr> </thead> <tbody> <tr> <td>0201</td> <td>2N</td> <td rowspan="3">10±1s</td> </tr> <tr> <td>0402, 0603</td> <td>5N</td> </tr> <tr> <td>0805</td> <td>10N</td> </tr> </tbody> </table>	尺寸 Size	F	保持时间 Duration	0201	2N	10±1s	0402, 0603	5N	0805	10N	<p>① 无外观损伤。 No visible damage.</p> <p>② $\Delta R25/R25 \leq 2\%$</p> <p>单位 unit: mm</p> <table border="1" data-bbox="1139 920 1501 1128"> <thead> <tr> <th>类型 Type</th> <th>a</th> <th>b</th> <th>c</th> </tr> </thead> <tbody> <tr> <td>0201</td> <td>0.25</td> <td>0.3</td> <td>0.3</td> </tr> <tr> <td>0402</td> <td>0.4</td> <td>1.5</td> <td>0.5</td> </tr> <tr> <td>0603</td> <td>1.0</td> <td>3.0</td> <td>1.2</td> </tr> <tr> <td>0805</td> <td>1.2</td> <td>4.0</td> <td>1.65</td> </tr> </tbody> </table> 	类型 Type	a	b	c	0201	0.25	0.3	0.3	0402	0.4	1.5	0.5	0603	1.0	3.0	1.2	0805	1.2	4.0	1.65
尺寸 Size	F	保持时间 Duration																															
0201	2N	10±1s																															
0402, 0603	5N																																
0805	10N																																
类型 Type	a	b	c																														
0201	0.25	0.3	0.3																														
0402	0.4	1.5	0.5																														
0603	1.0	3.0	1.2																														
0805	1.2	4.0	1.65																														

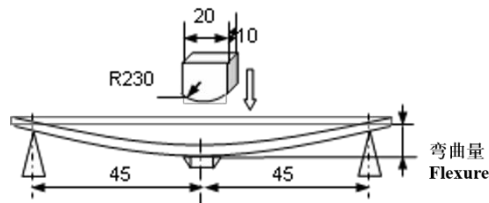

尺寸 Size	弯曲变形量 Flexure	施压速度 Pressurizing Speed	保持时间 Duration
0201,	1mm	<0.5mm/s	10±1s
0402, 0603, 0805	2mm		

<p>振动 Vibration</p>	<p>IEC 60068-2-80</p>	<p>① 将晶片焊接在测试基板上（如右图所示的环氧玻璃布板）； Solder the chip to the testing jig (glass epoxy board shown in the left) using eutectic solder.</p> <p>② 晶片以全振幅为1.5mm 进行振动，频率范围为10Hz ~55 Hz； The chip shall be subjected to a simple harmonic motion having total amplitude of 1.5mm, the frequency being varied uniformly between the approximate limits of 10 and 55 Hz.</p> <p>③ 振动频率按10Hz→55Hz→10Hz 循环，周期为1 分钟，在空间三个互相垂直的方向上各振动2 小时（共6 小时）。 The frequency ranges from 10 to 55 Hz and return to 10 Hz shall be traversed in approximately 1 minute. This motion shall be applied for a period of 2 hours in each 3 mutually perpendicular directions (total of 6 hours).</p>	<p>无外观损伤。 No visible damage.</p> 															
<p>坠落 Dropping</p>	<p>IEC 60068-2-32</p>	<p>从1m 的高度让晶片自由坠落到水泥地面10 次。 Drop a chip 10 times on a concrete floor from a height of 1 meter.</p>	<p>无外观损伤。 No visible damage.</p>															
<p>可焊性 Solderability</p>	<p>IEC 60068-2-58</p>	<p>① 焊接温度 Solder temperature: 245±5°C. ② 浸渍时间 Duration: 3±0.3s. ③ 焊锡成分 Solder: 96.5Sn/3.0Ag/0.5Cu. ④ 助焊剂Flux:（重量比）25%松香和75%酒精 25% Resin and 75% ethanol in weight.</p>	<p>① 无外观损伤； No visible damage. ② 元件端电极的焊锡覆盖率不小于95%。 Wetting shall exceed 95% coverage.</p>															
<p>耐焊性 Resistance to Soldering Heat</p>	<p>IEC 60068-2-58</p>	<p>① 焊接温度 Solder temperature: 260±5°C. ② 浸渍时间 Duration: 10±1s. ③ 焊锡成分 Solder: 96.5Sn/3.0Ag/0.5Cu. ④ 助焊剂 Flux:（重量比）25%松香和75%酒精 25% Resin and 75% ethanol in weight. ⑤ 试验后标准条件下放置1~2 小时后测量。 The chip shall be stabilized at normal condition for 1~2 hours before measuring.</p>	<p>① 无外观损伤； No visible damage. ② $\Delta R25/R25 \leq 2\%$ ③ $\Delta B/B \leq 1\%$</p>															
<p>温度周期 Temperature cycling</p>	<p>IEC 60068-2-14</p>	<p>① 无负载于下表所示的环境条件下重复5 次。 5 cycles of following sequence without loading.</p> <table border="1" data-bbox="443 1440 992 1630"> <thead> <tr> <th>步骤 Step</th> <th>温度 Temperature</th> <th>时间 Time</th> </tr> </thead> <tbody> <tr> <td>1</td> <td>-40±5°C</td> <td>30±3min</td> </tr> <tr> <td>2</td> <td>25±2°C</td> <td>5±3min</td> </tr> <tr> <td>3</td> <td>125±2°C</td> <td>30±3min</td> </tr> <tr> <td>4</td> <td>25±2°C</td> <td>5±3min</td> </tr> </tbody> </table> <p>② 试验后标准条件下放置1~2 小时后测量。 The chip shall be stabilized at normal condition for 1~2 hours before measuring.</p>	步骤 Step	温度 Temperature	时间 Time	1	-40±5°C	30±3min	2	25±2°C	5±3min	3	125±2°C	30±3min	4	25±2°C	5±3min	<p>① 无外观损伤； No visible damage. ② $\Delta R25/R25 \leq 2\%$ ③ $\Delta B/B \leq 1\%$</p>
步骤 Step	温度 Temperature	时间 Time																
1	-40±5°C	30±3min																
2	25±2°C	5±3min																
3	125±2°C	30±3min																
4	25±2°C	5±3min																
<p>高温存放 Resistance to dry heat</p>	<p>IEC 60068-2-2</p>	<p>① 在 125±5°C空气中，无负载放置 1000±24 小时。 125±5°C in air, for 1000±24 hours without loading. ② 试验后标准条件下放置1~2 小时后测量。 The chip shall be stabilized at normal condition for 1~2 hours before measuring.</p>	<p>① 无外观损伤； No visible damage. ② $\Delta R25/R25 \leq 2\%$ ③ $\Delta B/B \leq 1\%$</p>															

低温存放 Resistance to cold	IEC 60068-2-1	① 在-40±3°C空气中, 无负载放置 1000±24 小时。 -40±3°C in air, for 1000±24 hours without loading. ② 试验后标准条件下放置1~2 小时后测量。 The chip shall be stabilized at normal condition for 1~2 hours before measuring.	① 无外观损伤; No visible damage. ② $ \Delta R25/R25 \leq 2\%$ ③ $ \Delta B/B \leq 1\%$
湿热存放 Resistance to damp heat	IEC 60068-2-78	① 在40±2°C, 相对湿度90~95%空气中, 无负载放置1000±24 小时。 40±2°C, 90~95%RH in air, for 1000±24 hours without loading. ② 试验后标准条件下放置1~2 小时后测量。 The chip shall be stabilized at normal condition for 1~2 hours before measuring.	① 无外观损伤; No visible damage. ② $ \Delta R25/R25 \leq 2\%$ ③ $ \Delta B/B \leq 1\%$
高温负荷 Resistance to high temperature load	IEC 60539-1 5.25.4	① 在 85±2°C空气中, 施加允许工作电流 1000±48 小时。 85±2°C in air with permissive operating current for 1000±48 hours ② 试验后标准条件下放置1~2 小时后测量。 The chip shall be stabilized at normal condition for 1~2 hours before measuring.	① 无外观损伤; No visible damage. ② $ \Delta R25/R25 \leq 2\%$ ③ $ \Delta B/B \leq 1\%$

7 编带 Taping

类型 Type	0201	0402	0603	0805
编带厚度 Tape thickness(mm)	0.5±0.15	0.5±0.15	0.8±0.15	0.85±0.2
编带材质 Tape material	纸带 Paper Tape			
每盘数量 Quantity per Reel	15K	10K	4K	4K

(1) 编带图 Taping Drawings

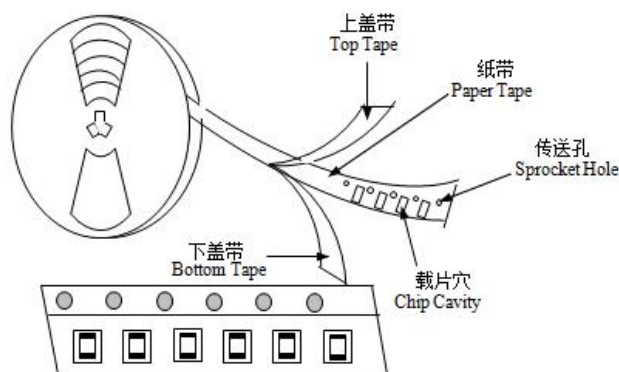

(2) 纸带尺寸 Paper Tape Dimensions

(单位 Unit: mm)

TN0201 系列 TN0201 series

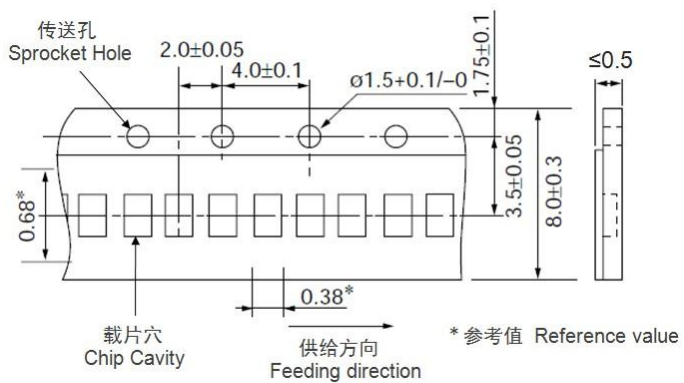

TN0402 系列 TN0402 series

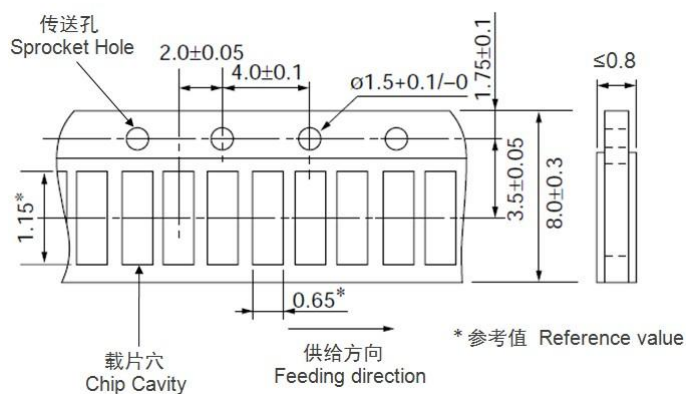

TN0603 系列 TN0603 series

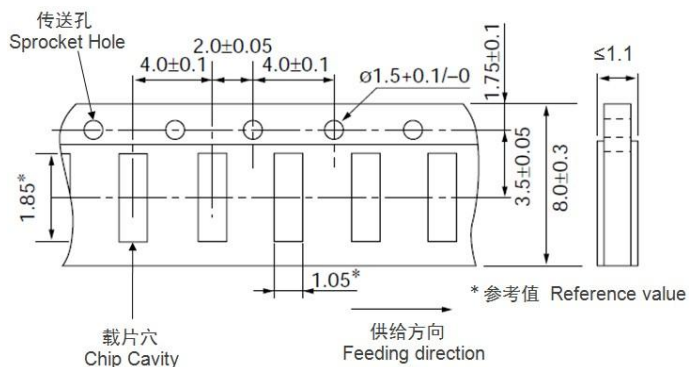

TN0805 系列 TN0805 series

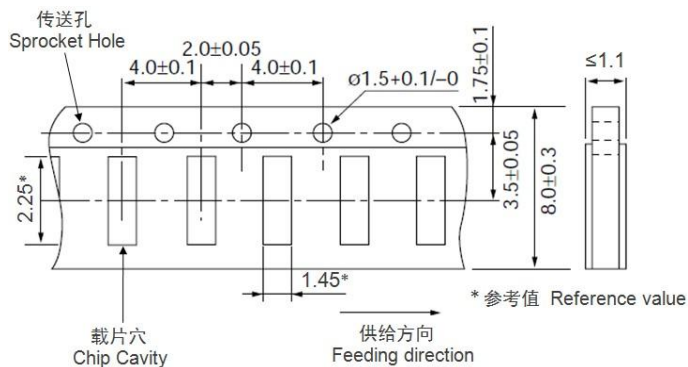

(3) 卷盘尺寸 Reel Dimensions (单位 Unit: mm)

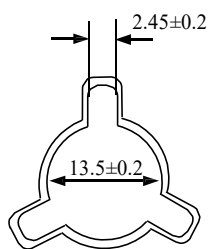
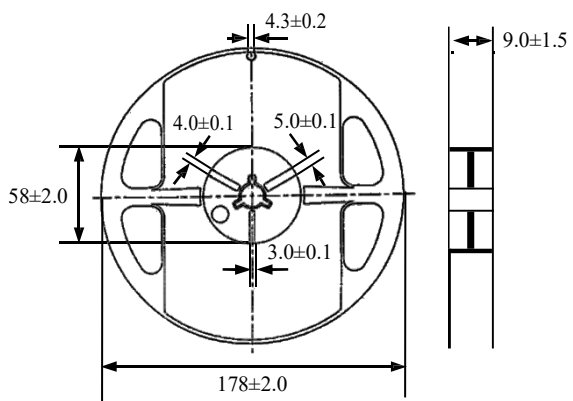

8 储存

储存条件

- a. 储存温度: $-10^{\circ}\text{C}\sim 40^{\circ}\text{C}$
- b. 相对湿度: $\leq 75\%RH$
- c. 避免接触粉尘、腐蚀性气氛和阳光

储存期限: 产品交付后6个月

9 注意事项

TN 系列热敏电阻不可在以下条件下工作或储存:

- (1) 腐蚀性气体或还原性气体(氯气、硫化氢气体、氨气、硫酸气体、一氧化氮等)。
- (2) 挥发性或易燃性气体
- (3) 多尘条件
- (4) 高压或低压条件
- (5) 潮湿场所
- (6) 存在盐水、油、化学液体或有机溶剂的场所
- (7) 强烈振动
- (8) 存在类似有害条件的其他场所

TN 系列热敏电阻的陶瓷属于易碎材料, 使用时不可施加过大压力或冲击。

TN 系列热敏电阻不可在超过目录规定的温度范围情况下工作。

8 Storage

● Storage Conditions

- a. Storage Temperature: $-10^{\circ}\text{C}\sim 40^{\circ}\text{C}$
- b. Relative Humidity: $\cong 75\%RH$
- c. Keep away from corrosive atmosphere and sunlight.

● Period of Storage: 6 Months after delivery

9 Notes & Warnings

The TN series thermistors shall not be operated and stored under the following environmental condition:

- (1) Corrosive or deoxidized atmospheres
(such as chlorine, sulfurated hydrogen, ammonia, sulfuric acid, nitric oxide and so on)
- (2) Volatile or inflammable atmospheres
- (3) Dusty condition
- (4) Excessively high or low pressure condition
- (5) Humid site
- (6) Places with brine, oil, chemical liquid or organic solvent
- (7) Intense vibration
- (8) Places with analogously deleterious conditions

The ceramic body of the TN series thermistors is fragile, no excessive pressure or impact shall be exerted on it.

The TN series thermistors shall not be operated beyond the specified "Operating Temperature Range" in the catalog.

10 建议焊接条件

回流焊

温升1~2°C/sec.

预热: 150~170°C/90±30 sec.

大于240°C时间: 20~40sec

峰值温度: 最高 260°C/10 sec.

焊锡: 96.5Sn/3.0Ag/0.5Cu

回流焊: 最多 2 次

10 Recommended Soldering Technologies

● Re-flowing Profile

■ 1~2°C/sec. Ramp

Pre-heating: 150~170°C/90±30 sec.

■ Time above 240°C: 20~40 sec.

■ Peak temperature: 260°CMax./10 sec.

■ Solder paste: 96.5Sn/3.0Ag/0.5Cu

■ Max.2 times for re-flowing

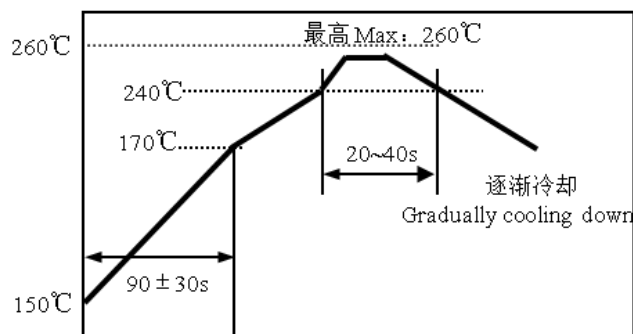

手工焊

烙铁功率: 最大20W

预热: 150°C/60sec.

烙铁头温度: 最高280°C

焊接时间: 最多3sec.

焊锡: 96.5Sn/3.0Ag/0.5Cu

手工焊: 最多 1 次

● Iron Soldering Profile

■ Iron soldering power: Max.20W

■ Pre-heating: 150°C/60sec.

■ Soldering Tip temperature: 280°CMax.

■ Soldering time: 3 sec Max.

■ Solder paste: 96.5Sn/3.0Ag/0.5Cu

■ Max.1 times for iron soldering

[注: 不要使烙铁头接触到端头]

[Note: Take care not to apply the tip of the soldering iron to the terminal electrodes.]

